

Owner's Manual

Android DVD Player

V5-4

Instructions for use

Thank you for purchasing this product, please read this manual carefully before use to ensure that you can use the machine correctly. After reading the instructions, please keep it for future inspection.

Caveat

To prevent damage to the machine and to use the system safely, please

- To prevent short circuits, do not omit metal objects (coins or other metal) inside the machine.

- Do not install the unit in a way that hinders the driver's sight or affects the driver's operation.

When you drive, please do not pay attention. In the system, do not watch the screen for a long time.

- The machine consists of high-precision components, should avoid a strong impact, not to unauthorized removal of the cover or adjust the parts, for maintenance, please go to a nearby professional service center consultation.

Before use

- When you purchase optional accessories or make related system settings, please check with the dealer whether they match the machine.

- You can select your favorite language display in the language setup menu. For more information, see Language Settings (page 4 of the manual)

Protect the display

- Protect the display from damage, do not use a ballpoint pen or sharp tool to touch the display.

- When the machine panel or display screen is dirty, wipe with a soft cloth and a mild

- You can not use hard cloth or alcohol and other corrosive thinner wipe the display or panel, so as to avoid the display or panel damage, blurred, the screen disappeared and so on.



- Please follow the instructions to use this machine, the damage caused by illegal operation is not covered by the warranty.

note

The machine display screen you see may be inconsistent with the picture of the manual, which is due to the unannounced software upgrade and update, does not affect the normal use.



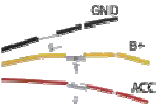







Some function (DVD, color LED, TV, etc.) is optional. The device which you purchase may not include all the functions that his manual listed.

Troubleshooting

malfunction	solution
Cannot power up 	Check the connection of ACC, B+, Ground. 1. Connect ACC with ignition line. 2. Connect B+ to the positive pole of the battery 3. Connect Ground to Ground.
No image when reversing	Connect the car DVD's reversing line with the car's reversing line, to ensure the reverse camera workable. 
Navigation does not work	1. If map goes wrong, uninstall then re-install the map 2. If map data destroyed, uninstall then re-install the map. 3. If GPS cannot search any signal, please check if the GPS antenna is well connected. If well connected, make sure the antenna is exposed to the air If still not working, please replace a new antenna.
The key light does not light	1. Check the headlight line connection. 2. Enable the button light on Setup

Basic operation

Definition of the keys

Serial number	name	Functional description
1		When device is working, press and hold about 1 second to power of the system; Short press to mute.
2	MAP	Map card slot
3	 MENU	Press to turn to home page
4	 RETURN	Return to the previous interface
5	 NAVI	Display navigation interface
6	RADIO	Display the radio interface
7	VOL+ VOL-	 Volume up  Volume down
8	 USB	USB slot
9		Disc insert/eject
10	SD	SD slot
11	Reset (RST/RES)	When the machine is not working properly, press this button and the machine will return to the factory settings.
12	 Phone	Display the Bluetooth phone screen
13	DVD	Display the DVD interface
14	Video	Play videos from an SD card or USB device
15	Music	Play music from an SD card or USB device
16	Seek 	·Search the previous chapter or the next chapter ·Search for the last channel or the next channel
17	Mute	Turn off the sound, button for muting
18	Disc insert slot	Insert the disc into the slot

Note: This table summarizes the definition of most of the panel buttons, but not every Model contains all the keys, some of the model contains only a small number of keys Which does not affect the use, if you have questions, please consult the dealer.

Open the system

Press the power button  1 second, activate the system.

Turn off the system

When the system is on, press and hold the power button  for 1 second to turn off the System.

Contents

Operation on the Home Screen

- >Home screen.....01
- >Source, network01
- > Backstage 01
- > Change the skin 01
- > Delete icons 02

Radio Operation

- > Radio Basic Operation 03
- > RDS03
- > Stores Channel 03

Bluetooth Control

- > Connecting 04
- > Hands-Free Call 04
- > Phone call 04
- > Phone book 05
- >Phone call record 05
- >Device connection 05
- >Bluetooth Setup 06
- >BT Music06

Rear Camera07

Multimedia

- >Music Player 08
- >Video Player 08

Caryplay and Android Auto connection

- >Carplay connection 09
- >Android Auto connection11

DSP

- >EQ Interface12
- >Curve Interface.....12
- >FAB Interface 12
- >Delay Interface12

Set up

- > Video settings 13
- > General13
- > Wi-Fi Setup..... 13
- > Bluetooth settings 13
- > Language Setup 14
- > Sound Effects 14
- > Navigator 14
- > Color LED..... 14
- >Steering wheel control(SWC).....15
- > Factory15
- > Original Car15
- > Android Settings 16
- > Upgrade &Reset 16
- > System Info 16
- >Interface definition 17



Split screen 18

Wiring Diagram 19

360 AVM 27

Operating instruction for main interface



Main interface

1. Press the button  , The interface will return to the default main interface.
2. Press the button  , it will display the interface of system applications and third-party applications. Slide to left or right interface as you want.

1

2



3. Long press  , Go to the small window interface, Press the **button** Can dear background running programs. Press the button  , can replace the main interface wallpaper.

3

4

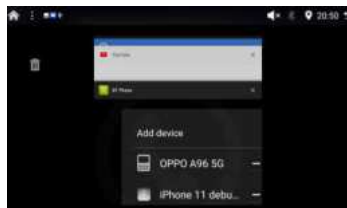

number	interface	number	interface
1	Initial media main interface	4	Background running program
2	Initial Media Main Interface	5	Replace the wallpaper interface
3	System applications and third-party application interface		

Remove the icons

1. Delete icon: Long press the APP, It will display "Do you want to uninstall this app?", click OK



Radio Operation

Radio Basic Operation



1. Select the FM1, FM2, FM3, AM1 or AM2 band
2. Frequency display
 - ◀ switches to previous frequency manually.
 - ▶ switches to next frequency manually
3. Displays the preset channel list, hold the key (P1-P6) to store the current broadcast frequency.
4. Multi function menu
 - 🔍 Tunes in a station with good reception automatically
 - 🔍 Short touch for non stop seek tuning, touch again to cancel. Long touch for switching the preset channels, long touch again to cancel.
 - 🔍 Change between Locate and DX mode.
 - 📶 Touch<RDS> to active the RDS function.
 - 📶 EQ and FAB setting, please see the EQ and FAB setting below
5. Mono and DX
 - DX X Displays LOC or DX.
 - Mono OM mm Displays Mono or Stereo, decided by the radio IC.

RDS

TP	Shows the traffic station is on or not
AF	Touch AF to light up, RDS can switch to stronger signal frequency when the current frequency is weak, but keep the contents same, only frequency different.
TA	Touch TA to light up, it can source the traffic info every minute, and stops to broadcast the traffic info once news come in.
PTY	Touch PTY to search by type

Stores Channel

1. Press the P1 key and hold to store the current channel to P1 key.
2. Press the P2 key and hold, then store the current channel to P2 key. If P3, then to P3 key etc.

Bluetooth Control

Connecting

Register your Bluetooth device

1. Active the Bluetooth on your phone
2. Touch search to search the Bluetooth waiting for pairing
3. Touch the Bluetooth Device name (j or ther) for connecting
4. Type the pin code (default code is 0000 or 1234) on your phone

Connecting a registered Bluetooth manually

1. Active the Bluetooth on your phone
2. Touch the to see the registered Bluetooth device list
3. Kick the box of the Bluetooth device name to connect
4. Type the pin code (default code is 0000 or 1234) on your phone

Delete a registered device

1. Touch the to see the registered Bluetooth device list
2. Cross the box of the device name
3. Touch the cross, and it tips "Do you want to unpair the Device?"
4. Touch OK, the device deleted

Hands-Free Call



1		Phone call record
2		Phone book
3		Dial Panel
4		Device list
5		Bluetooth settings

1) Phone call

Touch the , type the phone number, and click , phone call success as screen below, Cancel the phone call y touch the , and touch the to switch to speaker.



2)Phone book

Touch the  to enter the Bluetooth phone book interface, and follow the to download the phone book.

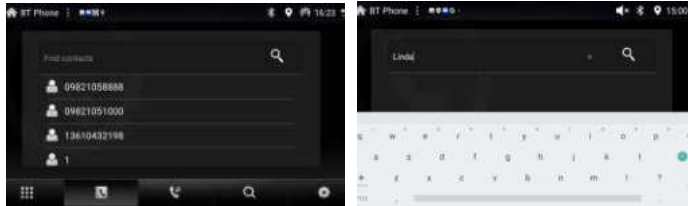



5)Bluetooth Setup

- 1.Touch the Bluetooth to change the Name
- 2.Sync phone book



3)Phone call record





	Dialed call
	Missed call
	Received call

Playing Bluetooth Audio Device

Click  into BT music and play music of the device connected by BT



	The last tune
	The next tune
	Play/Stop

4)Device connection



1.  Bluetooth Phone
2.  Bluetooth Music

Rear Camera

Note:The Reverse cable (pink color)of the power cable must be connected to the car's parking or reversing wire,then parking or reversing,the parking screen will automatically display.

Red connect with positive wire(B+)of the car backlight, black connect with the negtive wire(-) of the car back light.

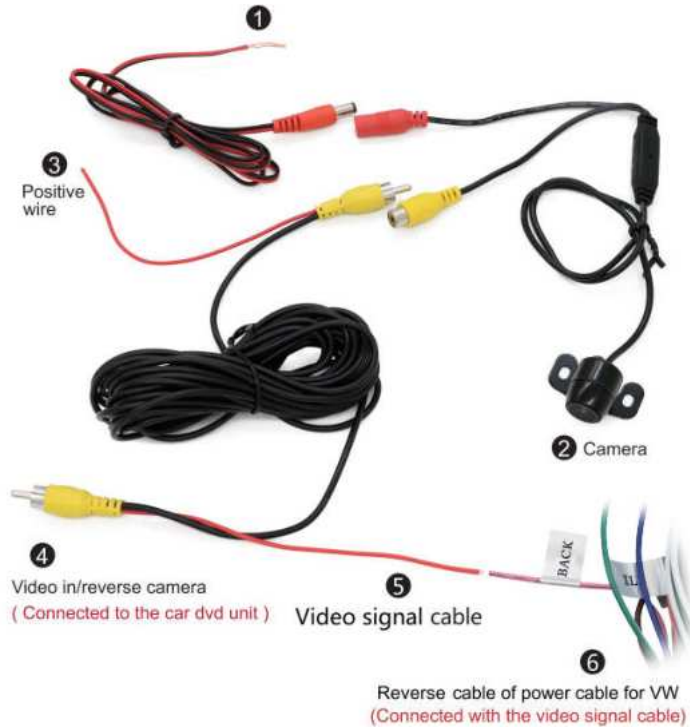

Note:For Car Navigation for Volkswagen (VW) with CANBUS,the video signal cable(5 red color) must be connected to the Reverse cable of the power cables.for other models no need to connect video signal cable to reverse cable.

Multimedia

Video Player



Music Player

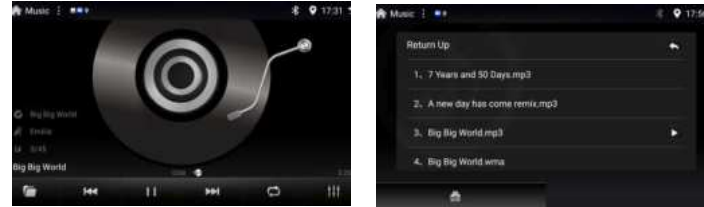

	Function		Function
	Back to the folder		The last tune
	Pause		The next tune
	Cycle mode		EQ

Note : The Music Player and the Video player works when the USB or the SD card is connected.And there are music or video in the USB or SD card.

Wireless Carplay connection

1:Click connections  to enter the connection interface ,click “add device” to choose the phone ,then click “tap to pair” .

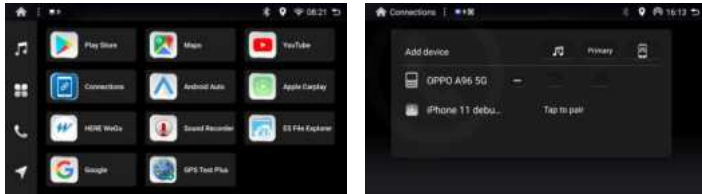

2. At the same time ,please Make sure your phone's BT is turned on, itwill show a window on the BT page ,click “Pair “ ,then click “Allow” in the phone,then click “Use Carplay”,then can enter Carplay interface successfully

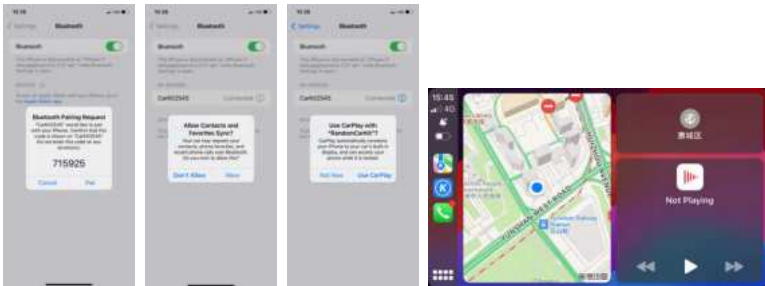

3:After connection successfully ,we can click Apple Link  to enter .





Wireless Android auto connection

1:Click connections  to enter the connection interface ,click “add device” to choose the phone ,then click “tap to pair” .

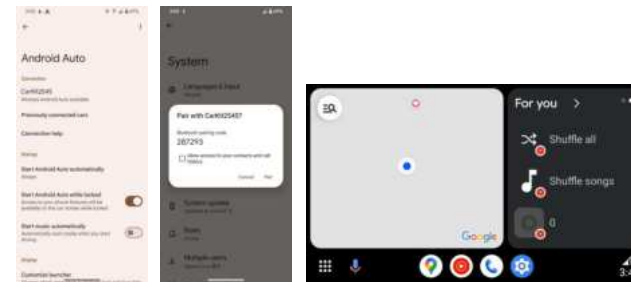

2. At the same time ,please Make sure your phone's BT is turned on,and the button for the Android auto is turn on ,it will show a window on the BT page ,cflck Pair ,then can enter Android auto interface successfully



3:After connection successfully ,we can click Android Link  to enter .



* Wired Android auto connection

Connect the Android phone with cable (OTG port),it will enter the Android Auto page automatically.

DSP Setting

- 1.EQ interface,you can choose sound effects,such as Flat,Pop,Rock,etc.
- 2.Curve interface,you can choose custom sound curve.



- 3.FAB interface,You can set the sound balance.
- 4.Delay interface,You can set the stereo and sound field delay.

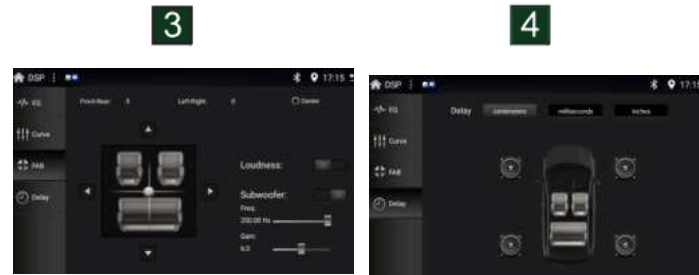

Set up

Video

·Touch [Video],if necessary.

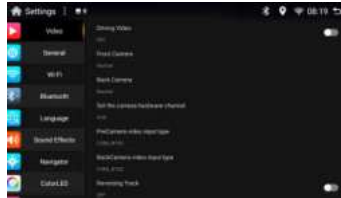

Parking-In Parking “Off mode,the screen will display Warning information if you play video.The warning Screen will prevent the driver from watching videos while the vehicle is in motion.

General

·Select an option to access/setup.

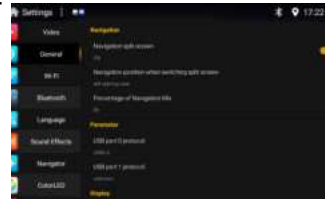
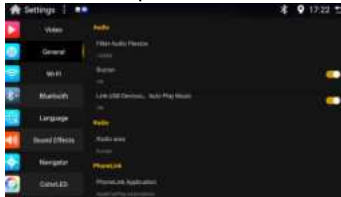

Wi-Fi Setup

·Turn on the Wi-Fi and search the available networks.
·Select a hotspot to connect.

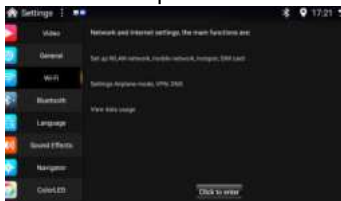

Bluetooth settings

·Manage Bluetooth devices.

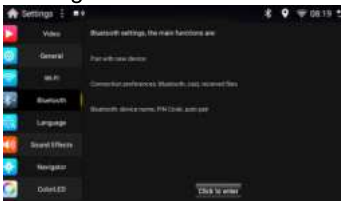

Language Setup

·Set Language



Source Volume Level

·Set the Volume Level of each Source.



Navigator

·Select a Navigation source from the available list.



Color LED

·Set the color of Keys on the front display



Steering Wheel Control Setup



Select [SWC] in the Settings menu to enter SWC setting menu.

- Select a function icon on the screen.
- Long press a steering wheel button.
- Repeat step 1 and 2 until all the settings are done.
- Touch [Save and Exit] after all buttons are set.
- To reset the programming, touch [Reset].

Factory

·Access Factory configuration.
Default Password:6666



Original Car

·View and manage CANBUS Settings.Default Password:0000



Android Settings

·View and manage the Android Settings.



Upgrade&Reset

·Upgrade the software &Reset the default settings.

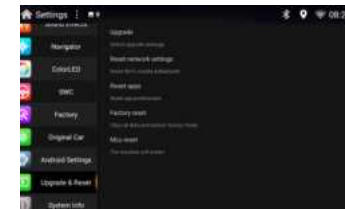

System Info

·View System Informations.



Interface definition

A:20Pin SIM card,audio and video socket



B:12Pin 360 panoramic interface



C:8Pin Plug-in protocol,audio output



D:4Pin USB1 socket(Optional)







E:6Pin USB2 socket



F:10Pin Reversing,handbrake,WIFI/BT antenna socket



Split screen

1. Press the Setup icon  select General  select Navigation split screen Open the button 
2. press the Navigation icon  Press the Split screen icon 

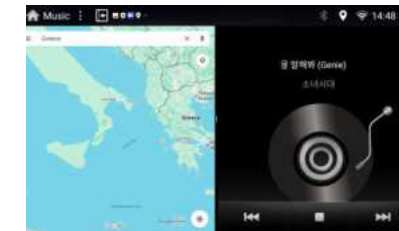
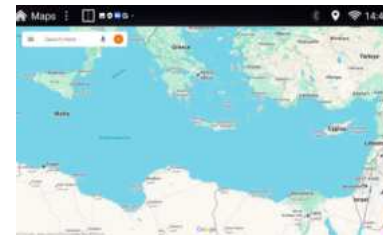

Wiring Diagram

Diagram of power cable and RCA Cable

Note: only work with INDC10.5V-16V power FM 87.5~108.0MHz Speaker prohibit grounding!

AM 522KHZ-1620KHZ

[1]

[2]

[1] Power Cable Diagram

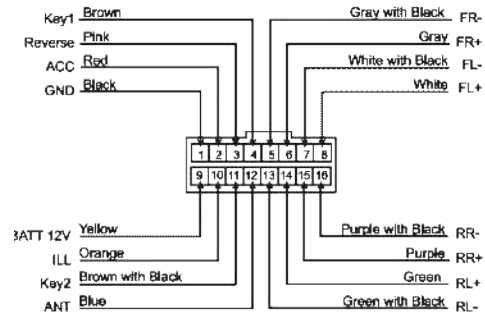

NO.	Name	Connection details	NO.	Name	Connection details
1	GND	For Ground Negative, must be connected	9	BATT 12V	For 12V Battery, must be connected
2	ACC	For Igniting Power, must be connected	10	ILL	Illumination Cable
3	Reverse	For Reverse Camera	11	Key2	For Steering Wheel Control Key2
4	Key1	For Steering Wheel Control Key1	12	ANT-CONT	
5	FR-	For Front Right Speaker -	13	RL-	For Rear Left Speaker-
6	FR+	For Front Right Speaker +	14	RL+	For Rear Left Speaker +
7	FL-	For Front Left Speaker -	15	RR+	For Rear Right Speaker +
8	FL+	For Front Left Speaker +	16	RR-	For Rear Right Speaker-

[2] RCA output socket

A

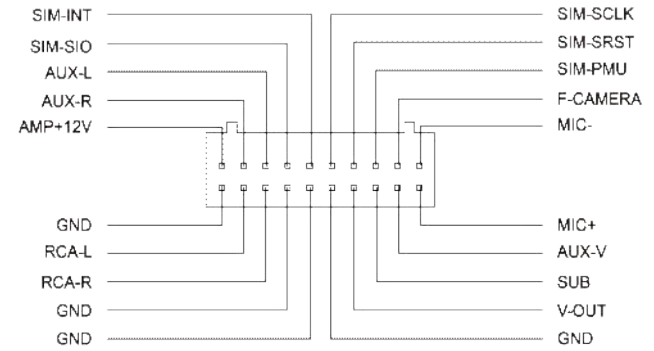

B

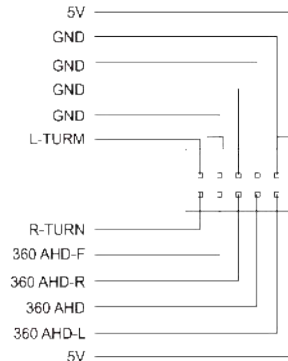

C

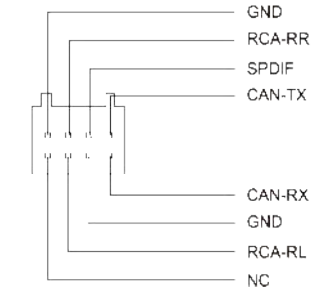

D

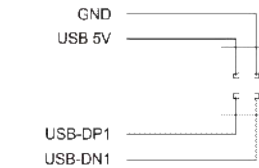

F

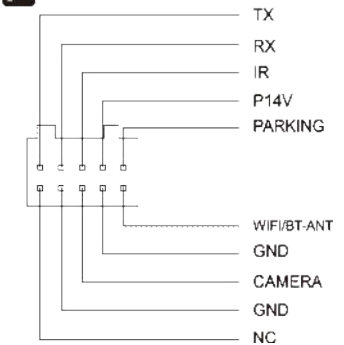

E

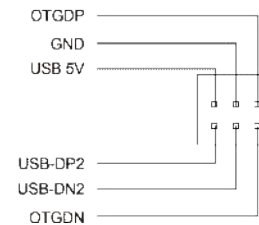

Wiring Diagram

Diagram of power cable and RCA Cable

Note: only work with INDC10.5V-16V power FM 87.5~108.0MHz Speaker prohibit grounding!

AM 522KHZ-1620KHZ

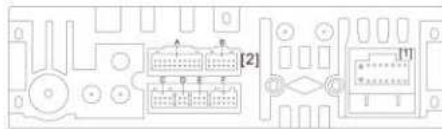
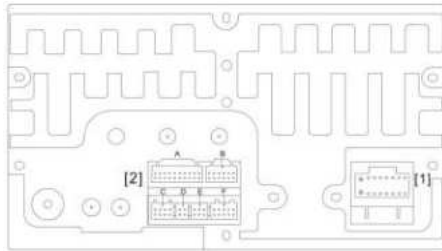

[1] Power Cable Diagram

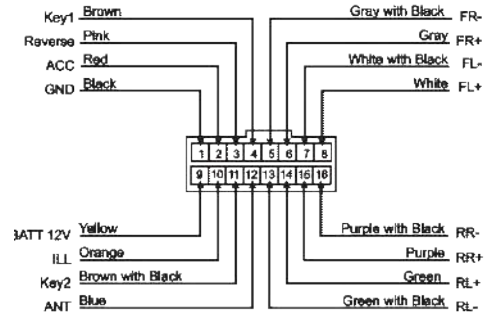

NO.	Name	Connection details	NO.	Name	Connection details
1	GND	For Ground Negative, must be connected	9	BATT 12V	For 12V Battery, must be connected
2	ACC	For Igniting Power, must be connected	10	ILL	Illumination Cable
3	Reverse	For Reverse Camera	11	Key2	For Steering Wheel Control Key2
4	Key1	For Steering Wheel Control Key1	12	ANT-CONT	
5	FR-	For Front Right Speaker -	13	RL-	For Rear Left Speaker-
6	FR+	For Front Right Speaker +	14	RL+	For Rear Left Speaker +
7	FL-	For Front Left Speaker -	15	RR+	For Rear Right Speaker +
8	FL+	For Front Left Speaker +	16	RR-	For Rear Right Speaker-

[2] RCA output socket

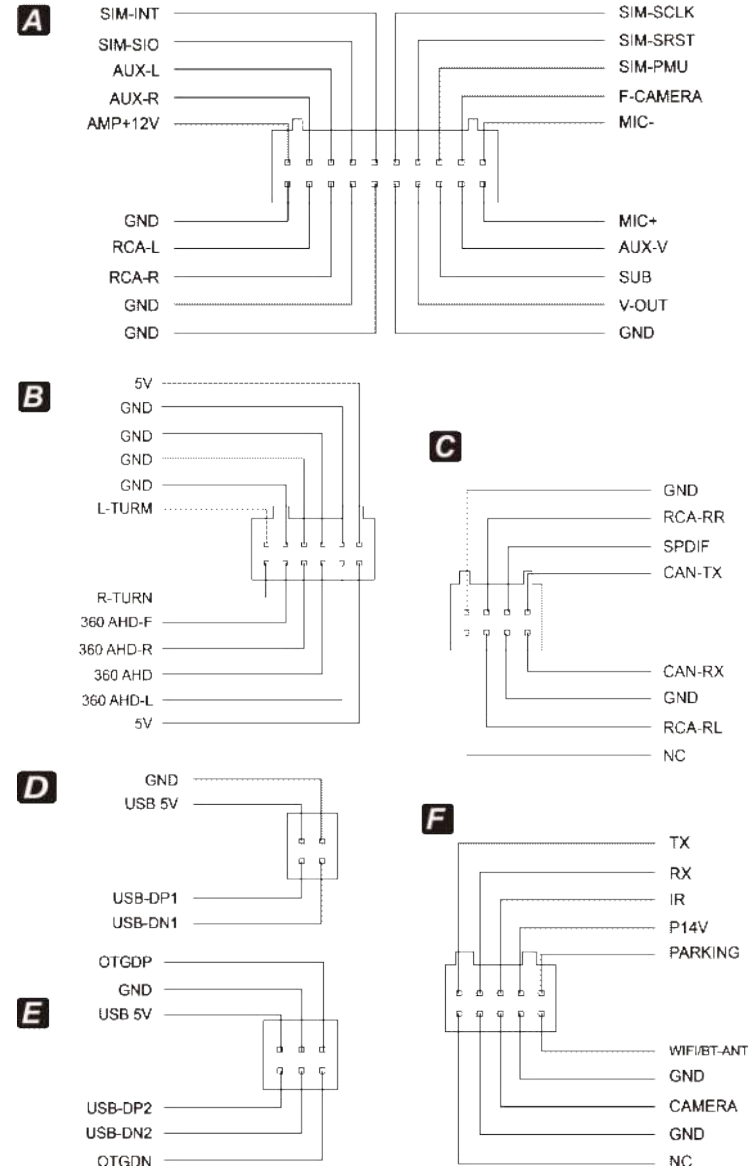

Wiring Diagram

Diagram of power cable and RCA Cable

Note: only work with DC10.5V-16V power
 FM 87.5-108.0MHz
 AM 522KHz-1620KHz
 Speaker prohibit grounding!

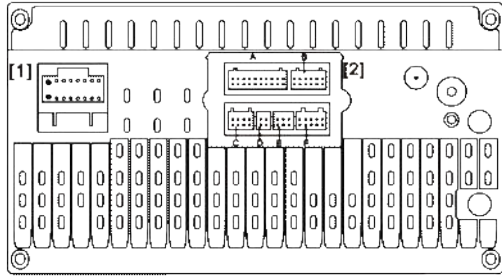

[1] Power Cable Diagram

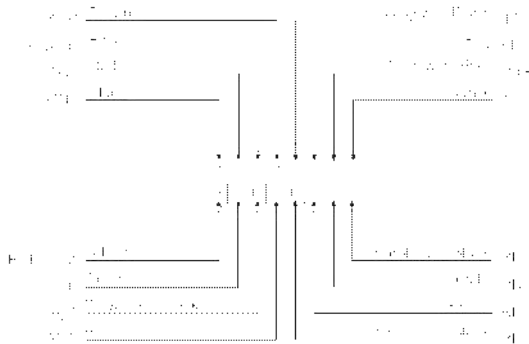

NO.	Name	Connection details	NO.	Name	Connection details
1	GND	For Ground Negative, must be connected	9	BATT 12V	For 12V Battery, must be connected
2	ACC	For Igniting Power, must be connected	10	ILL	Illumination Cable
3	Reverse	For Reverse Camera	11	Key2	For Steering Wheel Control Key2
4	Key1	For Steering Wheel Control Key1	12	ANT-CONT	
5	FR-	For Front Right Speaker -	13	RL-	For Rear Left Speaker-
6	FR+	For Front Right Speaker +	14	RL+	For Rear Left Speaker+
7	FL-	For Front Left Speaker -	15	RR+	For Rear Right Speaker+
8	FL+	For Front Left Speaker +	16	RR-	For Rear Right Speaker-

[2] RCA output socket

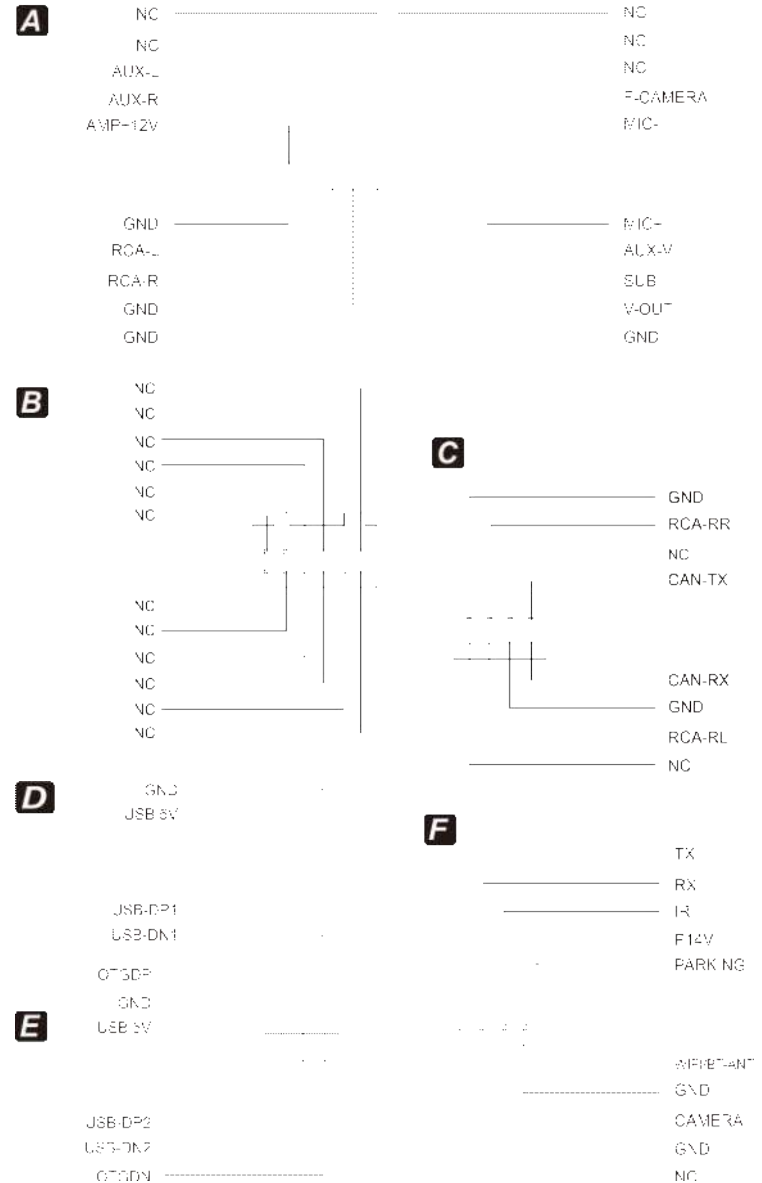

Wiring Diagram

Diagram of power cable and RCA Cable

Note: only work with DC10.5V-16V power FM 87.5~108.0MHz Speaker prohibit grounding!
AM 522KHz~1620KHz

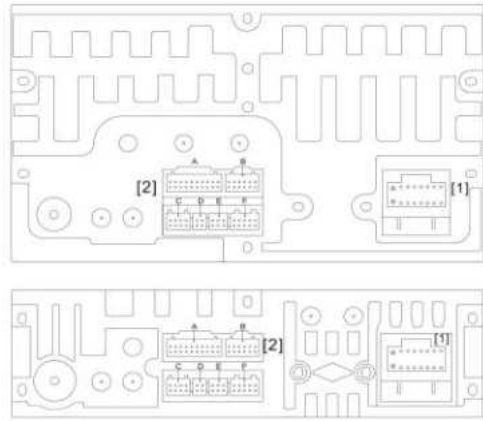

[1] Power Cable Diagram

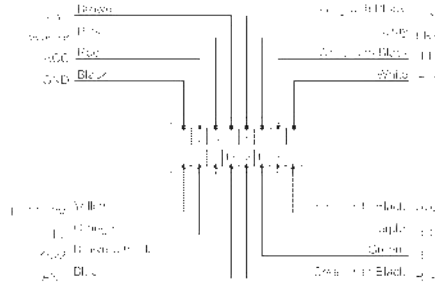

NO.	Name	Connection details	NO.	Name	Connection detail
1	GND	For Ground Negative,must be connected	9	BATT 12V	For 12V Battery,must be connected
2	ACC	For Igniting Power,must be connected	10	ILL	Illumination Cable
3	Reverse	For Reverse Camera	11	Key2	For Steering Wheel Control Key2
4	Key1	For Steering Wheel Control Key1	12	ANT-CONT	
5	FR-	For Front Right Speaker -	13	RL-	For Rear Left Speaker-r
6	FR+	For Front Right Speaker +	14	RL+	For Rear Left Speaker +
7	FL-	For Front Left Speaker -	15	RR+	For Rear Right Speaker +
8	FL+	For Front Left Speaker +	16	RR-	For Rear Right Speaker-

[2] RCA output socket

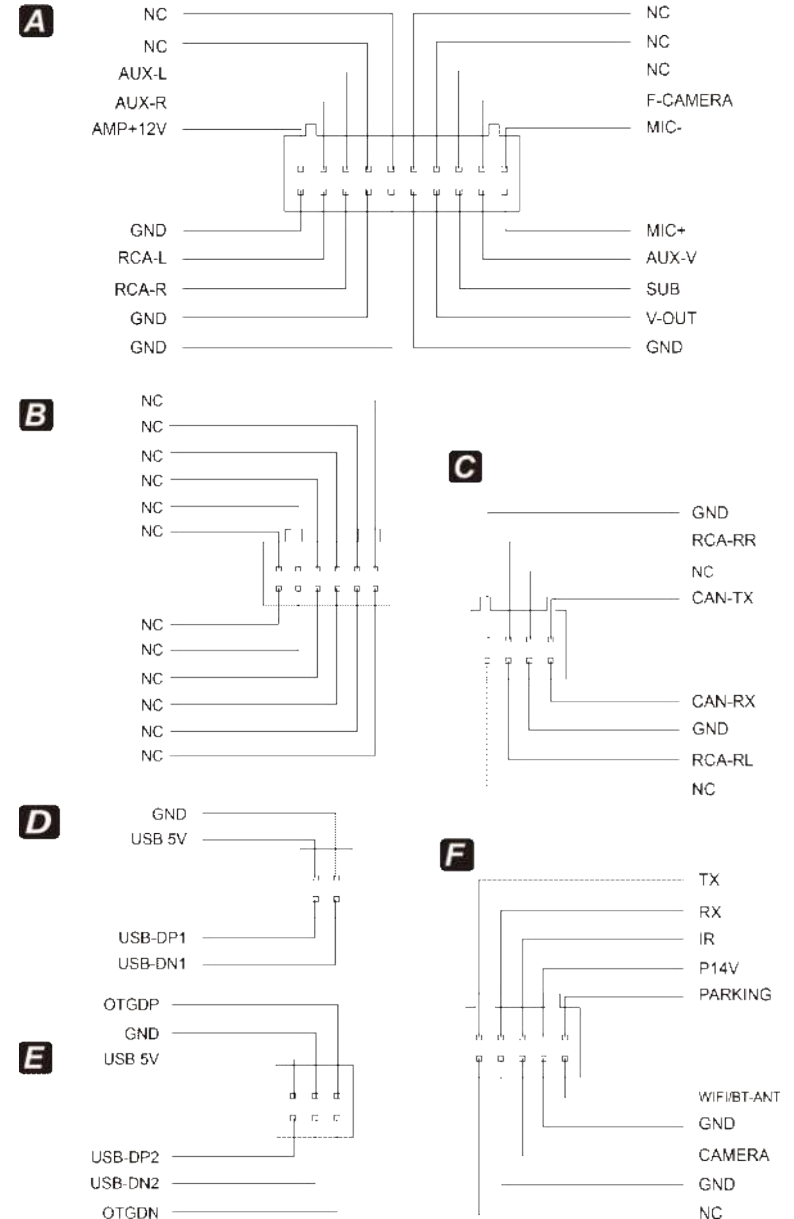

360AVM



360 parking system cable connect instruction



①	12Pins Video input(Connected to the car dvd unit)		
②	Left Turn Signal+(Red connect with positive wire ofthe car Leftlight)		
③	Right Turn Signal+(Red connect with positive wire ofthe car Right light)		
④	Reversing Light+(Red connect with positive wire ofthe car Back light)		
⑤	LeftCamera	⑥	Right Camera
⑦	Rear Camera	⑧	Front Camera
⑨	Front camera power cable		

NOTE:Must connect 360 AVM rear cable,Not support AHD rear and front camera cable, it will cause no picture shown on the rear page.

360 parking system instruction

1.Enter the  setting page select the Video item 

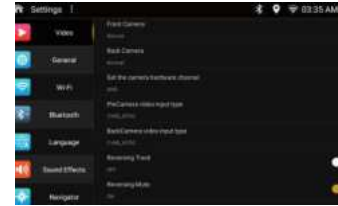

2.Click the"Set the camera hardware channel item ,and select then "AVM",then back to the home page and will show a reboot window on the unit ,please wait for the unit finish reboot.

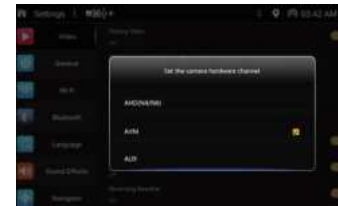

3.According to the camera manual select the match parameter.(like photo) 



4.After finish setting ,return to homepage,it will shown a window said the unit need reboot After finish reboot,it will show a 360 rear icon if not shown the wind how,please reboot the head unit by hand.

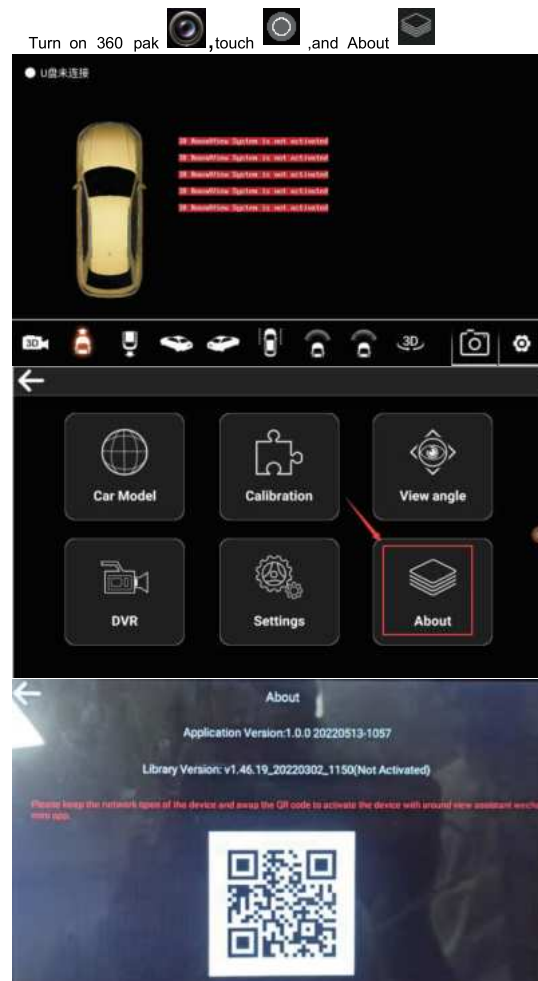

· Active 360 AVM apk

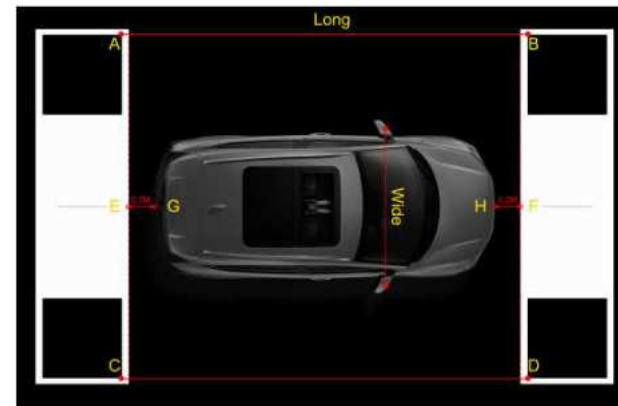

·Calibration

1.Place the calibration cloth in the center of the front and rear of the car.The distance between the calibration cloth and the car is 20-30 cm.Put the calibration cloth as picture below:



2.Turn on 360 pak , touch , and enter setting 



3.Click the "Calibration" option enter the password "8888" to enter the splicing page, And click the "CALIBRATE" option.



4. Select the corresponding calibration cloth, click to enter, input the "Length of Vehicle", "Width of vehicle" and "Vehicle height", click "ONE-CLICK IMAGE STITCHING" and wait a while for automatic stitching completed.

Note:

- ① make sure that the four cameras (Front, Rear, Left, Right) can see the calibration cloth.
- ② for the "Length of Vehicle", "Width of vehicle" and "Vehicle height", you can check online, or measure by yourself.

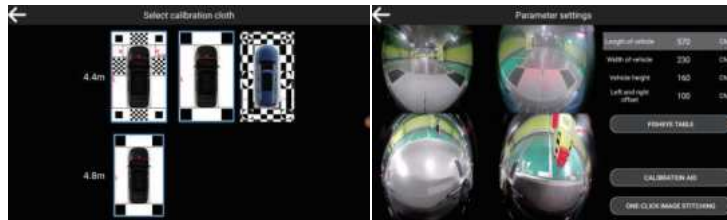

5. If the automatic stitching works well, the calibration is done and you can park with the 360 panorama.

If the automatic stitching effect is not satisfactory, you can do manual stitching. Check whether the calibration points are aligned with the four vertices of the square on the calibration cloth. If there is any deviation, click the screen calibration to align. After all the four images are manually aligned, click the "CALIBRATE" icon to complete the splicing.

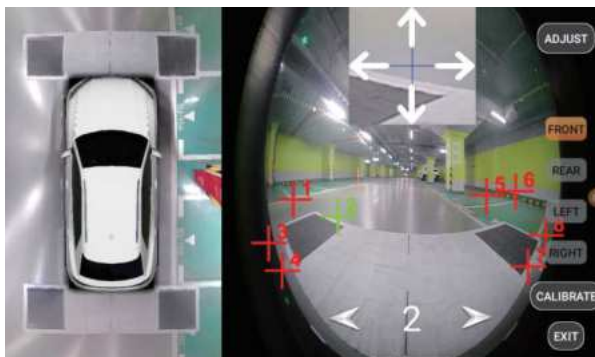

Touch the home icon, touch the camera icon, click the AV icon and enter the AVM page.











Touch the 2D icon, enter the page 1. Touch the 2D icon, enter the page 2. Touch the 2D icon, enter the page 2.



The page 1, 2D page.













- 1. Click the car model front, rear, left, right side, the right side picture on unit screen will follow to switch.
- 2. Double click the left side view, it will enter Panorama picture, and click the screen twice, it will back to default model.







	Switch to 3D view		
	Front view		Front view eliminate distortion
	Rear view		Rear view eliminate distortion
	Left view		Left view eliminate distortion
	Left rear side view-3D angle, shown around the car left rear view.		
	Front left side view-3D angle, shown around the car front left view.		
	Right view		Right view eliminate distortion
	Right rear side view-3D angle, shown around the car right rear view.		

	Left front side view-3D angle,shown around the car left front view.
	Limit of front wheel width view angle-vertical view shown on screen middle.
	Front wheel line width view angle-vertical view shown on screen left side.
	Car front side-when car front radar sounding.click this for enter front view.
	Car front side-when car rear radar sounding.click this for enter rear view.
	Widthwise vertica view-when car rear radar sounding.click this for enter rear view
	Front triad screen -with more view angle
	Rear triad screen -with more view angle

The page2 **2** ,3D view page.

- 1.Click the car model front ,rear ,left, righ side,the right side picture on unit screen will follow to switch.
- 2.Double ckle the left side view,jit will entre Panorama picture,and click the screen twice,it will back to defaul

	Switch to 2D view		
	Front view		Front view-3D front view
	Rear view		Rear view-3D rear view
	Left rear side view-3D angle,shown around the car left rear view.		
	Front left side view-3D angle,shown around the car front left view.		
	Right rear side view-3D angle,shown around the car right rear view.		
	Leftfront side view-3D angle,shown around the car left front view.		
	Limit of front wheel width view angle-vertical view shown on screen middle.		
	Front wheel line width view angle-verticalview shown on screen leftside.		
	Car front side-when car front radar sounding.click this for enter front view.		

	Car front side-when car rear radar sounding.click this for enter rear view.
	Widthwise vertical view-when car rear radar sounding.click this for enter rear view.
	Front triad screen -with more view angle.
	Rear triad screen -with more view angle.
	3D rotation.
	Take photo.-support taking photo during deriving car.
	Setting -enter system setting

SETUP



①	Return
②	Car Model.Select car model shown on screen
③	Calibration.Password 8888
④	View angle.Password 8888
⑤	DVR.Driving record and photos
⑥	Settings
⑦	About.

·Car Mode



①	More vehicles.Click to select car model
②	My garage.Three car models (Sedan SUV MPV)
③	Track style(15 rearing track line model). (In default setting,there are no rearing track liner,must select one tracking line model to show on screen)
④	View angle mode,four default view angle(10°,20°,30°,45°)
⑤	Vehicle color.
⑥	Car mode.

·View angle

Password 8888 , Please find a professional to finish view setting,also can follow the video to finish calibration.

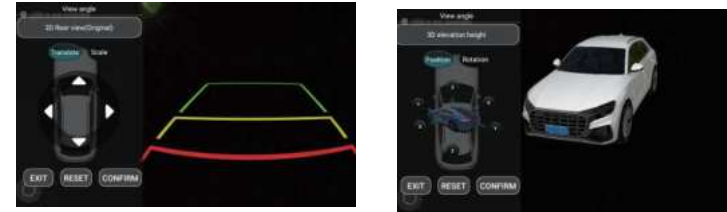

·DVR

Support diving record and photos,also support the adjust setting.



①	Car driving video.	②	Driving photo
③	Date	④	Setting(Picture 2)
⑤	Show	⑥	Delete the record
⑦	Clear all	⑧	Setting storage path (external storage device)
⑨	Driving record video time(3min 5min 10min)		
⑩	Turn on or off the record function	⑪	Format files

• Setting

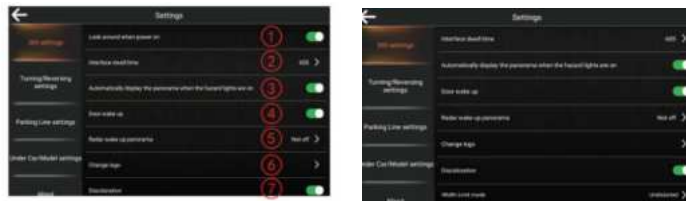

360 settings			
①	Look around when power on	②	Interface dwell time
③	Automatically display the panorama when the hazard lights are on		
④	Door wake up	⑤	Radar wake up panorama
⑥	Change logo	⑦	Discoloration
⑧	Width Limit mode		



Turning/Reversing settings			
①	Automatically start panoramawhen turning on the turn signal lamp (Must turn on thesecond item so the item be vaild)		
②	Steering control vehicle speed threshold		
③	Streeringdwelltime	④	Parking time in reverse



Parking Line settings	
①	Trajectory reversal
②	Ruler line

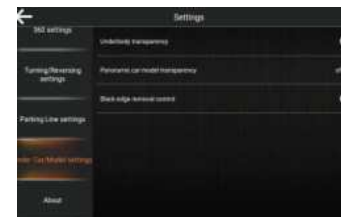

Under Car/Model settings	
①	Underbody transparency
②	Panoramic car mode transparency
③	Black edge removal control



About (Activate methods 1)	
1.Head unit connect to internet.	
2.Click the button ① to finish activation	

NOTE:This instruction only for functional operation guide,the icons shown on this instruction might by different to the real one shown on the head unit,please refer to the actual product.

Thanks for using our system.
Wish you have a safe trip and enjoy your life.